

# Data Sheet



Article number: 03555035

Description: Fluro hydraulic rod end FS 35C

## Measures

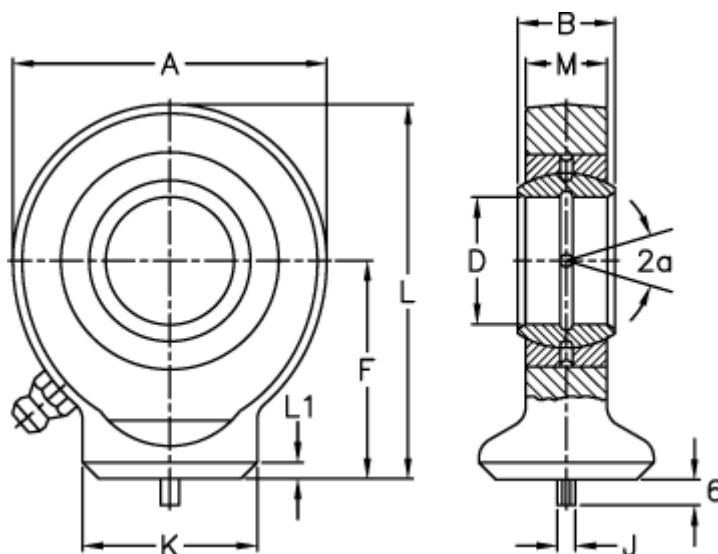

A	= 82	L	= 102
a (degrees)	= 6	L1	= 4
B	= 25	M	= 21
D	= 35	Static load C0 (kN)	= 125
Dynamic load C (kN)	= 80	Weight	= 950
F	= 61		
J	= 4		
K	= 47		